

# transform

your expectations



commercial doors





# collaboration



## A New Perspective

Opening up new possibilities and pushing the limits are easy with Clopay's diverse line of commercial doors. You'll have an award-winning selection to choose from that can help you redefine how others see your building.



on every level



When you choose Clopay for your commercial doors, you'll have access to a network of dealers who are ready to provide one-on-one collaboration. You'll work directly with a commercial door expert who will take the time to show you inspiring choices and help you reinvent your space with creative options. Whether your goal is to improve energy efficiency, let in more light or transform your space for a new application, Clopay will help you find the perfect solution on your terms.



Model 3720, 12'2" x 14' Doors; Interior Shown  
with 24" x 8" Lites and 14 Gauge Hinges

## Commercial-Grade Tools

Clopay collaborates with popular online resources to provide architects, specifiers, building owners and contractors the tools needed to properly specify commercial products and learn about LEED credits. Clopay offers Continuing Education with AIA certified courses on topics including wind load, fire doors and sectional door basics.

Need help with a specification?

Visit [clopaycommercial.com](http://clopaycommercial.com) or email [CIA@clopay.com](mailto:CIA@clopay.com)

### Specification Tools



### Building Information Management





# explore your choices

Clopay offers a diverse selection of commercial doors that are uniquely suited to meet a wide array of specifications. Whether your primary need is durability, energy efficiency or versatility, Clopay has a door that will help you transform your space.



	ARCHITECTURAL SERIES Aluminum Full-View Doors	ARCHITECTURAL SERIES Steel Full-View Doors	ENERGY SERIES WITH INTELICORE® Polyurethane Insulated Steel Doors	ENERGY SERIES Polystyrene Insulated Steel Doors	INDUSTRIAL SERIES Ribbed Steel Doors	ROLLING STEEL SERIES Rolling Steel Doors
EASE OF OPERATION	★★★★★	★★★★★	★★★★★	★★★★★	★★★★★	★★★
APPEARANCE/DESIGN	★★★★★	★★★★★	★★★★	★★★★	★★★	★★
DURABILITY	★★★★★	★★★★★	★★★★★	★★★★	★★★	★★★★★
COST OF OWNERSHIP	★★★	★★	★★	★★	★★★	★
ENERGY EFFICIENCY	★★	★★★★	★★★★★	★★★★	★★★	★★
INITIAL COST	★★★★	★★★★	★★★	★★	★★	★★★★★

# architectural series



Model 904, 12'2" x 14' Clear Aluminum Doors; Shown with Tempered Insulated Glass

## ALUMINUM FULL-VIEW DOORS

Clopay's Aluminum Full-View doors offer flexibility to allow varying degrees of light while complementing the surrounding structure. A wide selection of standard and custom glazing types and finishes make a bold statement in retail, service stations, restaurants and other environments requiring visibility or light.

### MAXIMUM DURABILITY

- 2-1/8" (54 mm) thick section construction, 6063-T5 extruded aluminum alloy frame. Integral interior reinforcement fin standard on Models 902/903 and where necessary on Model 904.
- Tongue-and-groove meeting rail.
- New Model 904 features contemporary boxed frame design with integral section joint seal.
- 902/903 features capped rail construction.

### VERSATILITY AND DESIGN FLEXIBILITY

- Numerous glazing options include insulated, Low-E, frosted, mirrored, tinted and polycarbonate panels in various colors. Most glass types include tempered option.
- Wide variety of anodized, powder-coated and painted options, including Color Blast® Finish.
- 904 has consistent panel widths and heights.
- 903 has consistent panel widths (height may vary).
- 902 has varied panel width 44" on center (end panels and height may vary).



Section Joint Seal (904)



Reinforcing Fin (904 - where applicable)



Reinforcing Fin (902/903)



NEW MODEL 904

MODELS 902/903

## PANEL OPTIONS



Aluminum Full-View (904)



Solid Aluminum (904)



Aluminum Full-View (902, 903)

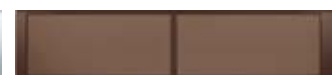

Solid Aluminum (902, 903)

Acrylic windows require special cleaning. Never use products that contain ammonia or petroleum products to clean acrylic. Please visit [clopaydoor.com/acrylic](http://clopaydoor.com/acrylic) for complete details.



## GLASS/PANEL OPTIONS

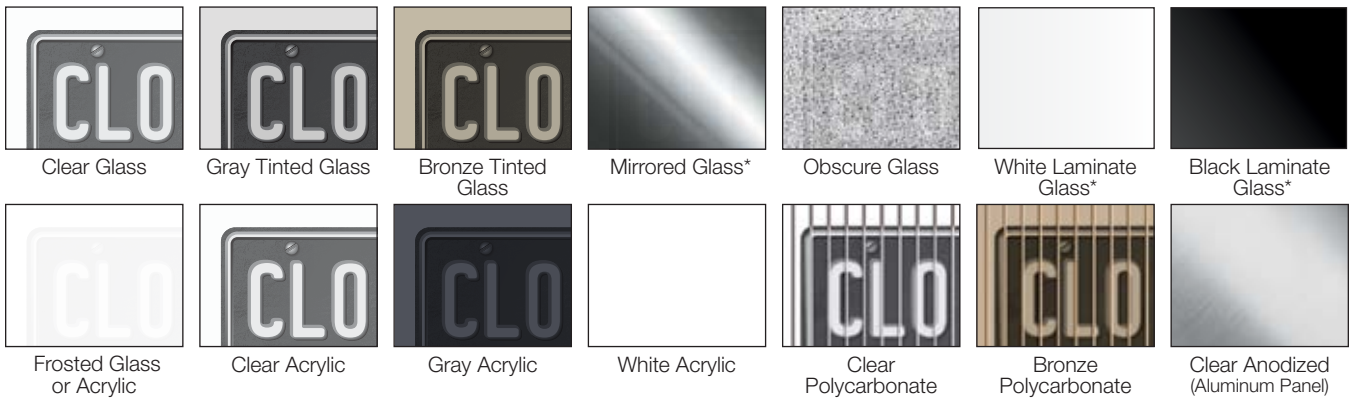

\*Mirrored and laminate not available in 1/2".

Glass thickness available in 1/8", 1/4" and 1/2". Low-E available on insulated glass. Tri-wall polycarbonate thickness available in 1/2". Aluminum panels can be color matched to frame. Glass/acrylic panels may be combined with aluminum panels.

## FRAME/SOLID PANEL COLOR OPTIONS



\*\*Additional cost may apply.

<sup>†</sup>Due to the anodizing process, slight color variation may occur. The use of "Bronze (Painted)" is recommended for a more consistent bronze finish color. Custom powder coat and Color Blast® finish available. See your Clopay Dealer for details.

# architectural series

Model 3729, 12'2" x 12' Doors;  
Shown with 42" x 16" Lites

## STEEL FULL-VIEW DOORS

Clopay's Steel Full-View doors are durable, energy efficient and offer excellent visibility and design options. These doors are a perfect fit for commercial, retail, restaurant and industrial facilities where ease of maintenance, versatility, energy efficiency and durability considerations are all important.

### MAXIMUM DURABILITY AND ENERGY EFFICIENCY

- Three-layer construction with thermal break section joints.
- 2" (50.8 mm) or 1-3/8" (34.9 mm) thick models with Intellicore® polyurethane or polystyrene insulation bonded to the interior and exterior steel skins.
- R-values up to 18.4\*.

### LOW MAINTENANCE WITH LASTING FINISH

- Hot-dipped galvanized steel skin with a baked-on primer and top coat.

### VERSATILITY AND DESIGN FLEXIBILITY

- Injection-molded window frames with multiple glazing, size and visibility options.
- New 37" x 8" contemporary slim window frame in black or silver aluminum. Many glass options available.
- Impact rated window options available.
- Minor ribbed or flush exterior skin.
- Variety of color options.

### PEACE OF MIND

- Ten-year paint and delamination warranty.

\*R-value is impacted by the number of windows and window type per section. Calculated R-values for doors featuring a full row of windows, in both insulated and non-insulated glass, is available on our website. Calculated door section R-value is in accordance with DASMA TDS-163.

### PANEL OPTIONS

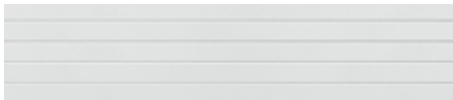

Minor Ribbed – Stucco Embossed  
(3159, 3209, 3709, 3729)



Flush – Stucco Embossed  
(3158, 3208, 3708, 3728)

### WINDOW OPTIONS



19-1/2" x 16" – Injection Molded Frames  
(3158, 3159, 3208, 3209, 3708, 3709, 3728, 3729)



42" x 16" – Injection Molded Frames  
(3158, 3159, 3208, 3209, 3708, 3709, 3728, 3729)



37" x 8" – NEW Slim Windows with Aluminum Frame  
(3208, 3209, 3728, 3729)  
Available November 2020



Model 3208, 12' x 12' Doors with 37" x 8" Lites





# energy series with intellicore

## POLYURETHANE INSULATED STEEL DOORS

Clipay's polyurethane insulated steel premier doors provide increased energy savings and advanced comfort using our innovative Intellicore® insulation technology. These doors are a smart choice for climate-controlled manufacturing facilities, warehouses, schools, office spaces and retail facilities.

### MAXIMUM DURABILITY AND ENERGY EFFICIENCY

- Three-layer construction with thermal break section joints.
- 3" (76.2 mm), 2" (50.8 mm) or 1-3/8" (34.9 mm) thick models with Intellicore® polyurethane insulation bonded to the interior and exterior steel skins.
- R-values up to 27.2\*.
- Exterior skin gauge options include 20, 24 or 27 gauge.

### LOW MAINTENANCE WITH LASTING FINISH

- Hot-dipped galvanized steel skin with a baked-on primer and top coat.

### VERSATILITY AND DESIGN FLEXIBILITY

- Injection-molded window frames with multiple glazing and window sizes. Aluminum full-view sections available in clear anodized, and painted white and chocolate.
- Glazing options include DSB, tempered, plexiglass, insulated, insulated tempered and polycarbonate.
- Multiple steel texture embossments, panel designs and window options.
- Variety of color options.

### PEACE OF MIND

- Ten-year paint warranty.

\*Calculated door section R-value is in accordance with DASMA TDS-163.

### PANEL OPTIONS

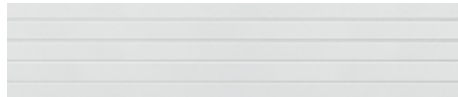

Minor Ribbed – Stucco Embossed  
(3715, 3717, 3720, 3724, 3730)



Flush – Stucco Embossed  
(3718, 3722)



Flush – Woodgrain Embossed  
(3721)



Elegant Raised – Woodgrain Embossed  
(3723)

### WINDOW OPTIONS



24" × 8"  
(3715, 3717, 3718, 3720, 3724, 3730)



24" × 12"  
(3715, 3717, 3718, 3720, 3724, 3730)



Aluminum Full-View  
(3715, 3717, 3718, 3720, 3724)



26" × 13" – Double Pane Polycarbonate Glazing  
(3715, 3717, 3720, 3724)



19-1/2" × 12"  
(3721, 3723)



40-1/2" × 12"  
(3721, 3723)



Model 3724, 14'2" × 14' Doors;  
Shown with 24" × 8" Lites

intellicore<sup>®</sup>  
insulation technology



WARMER.  
QUIETER.  
STRONGER.

Commercial doors featuring Intellicore<sup>®</sup> insulation technology represent the ultimate smart choice. Clopay's Intellicore<sup>®</sup> insulation is a proprietary polyurethane foam that is injected into the door, expanding to fill the entire structure. The result is a door with incredible strength and durability. Its dense insulation also produces a quieter door, while its industry-leading R-values (up to 27.2) provide year-round comfort and improved energy efficiency.

**durable** and  
energy efficient

# energy series

## POLYSTYRENE INSULATED STEEL DOORS

Clopay's Energy Series doors provide durability and enhanced comfort using our high-quality polystyrene insulation, three-layer construction and thermally broken section joints. These doors are an effective choice for industrial facilities, municipal buildings, warehouses and shipping docks under demanding conditions.

### DURABILITY AND ENERGY EFFICIENCY

- Three-layer construction with thermal break section joints.
- 2" (50.8 mm) or 1-3/8" (34.9 mm) thick models with polystyrene insulation bonded to the interior and exterior steel skins.
- Exterior skin gauges options include 20, 24 or 27 gauge.
- R-values up to 9.1\*.

### LOW MAINTENANCE WITH LASTING FINISH

- Hot-dipped galvanized steel skin with a baked-on primer and top coat.

### VERSATILITY AND DESIGN FLEXIBILITY

- Injection-molded window frames with multiple glazing and window sizes. Full-view section options in pre-painted Standard White or Chocolate available.
- Multiple steel texture embossments, panel designs and window options.
- Variety of color options.

### PEACE OF MIND

- Ten-year paint and delamination warranty.

\*Calculated door section R-value is in accordance with DASMA TDS-163. Polystyrene CFC and HCFC free.

### PANEL OPTIONS

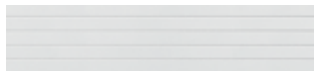

Minor Ribbed – Stucco Embossed  
(3150, 3200)



Flush – Stucco Embossed  
(3220)



Flush – Woodgrain Embossed  
(3155, 3211)



Elegant Raised – Woodgrain Embossed  
(3154, 3213)

### WINDOW OPTIONS



24" × 8"  
(3150, 3200)



24" × 12"  
(3150, 3200)



Aluminum Full-View  
(3150, 3200)



19-1/2" × 12"  
(3211, 3213)

Model 3150, 12' × 14' Doors; Shown with 24" × 8" Lites



3-layer bonded polystyrene doors are 2" or 1-3/8" sandwich construction

Model 520, 10'2" x 14' Doors; Shown with 24" x 6" Lites

# industrial series

## RIBBED STEEL DOORS

Clopay's Industrial Series doors feature a variety of panel designs and a wide selection of steel gauges to meet your design, durability and budget requirements. These doors are a great choice for high traffic applications including industrial facilities, warehouses, distribution centers and loading docks.

### DURABILITY AND ENHANCED COMFORT

- One or two-layer construction in 20, 24 and 25 gauge options.
- Two-layer models include polystyrene insulation with optional vinyl ( 524V, 525V and 664V) or steel back (520S, 522S, 524S and 525S).
- R-values up to 6.6\*.

### EASE OF MAINTENANCE WITH LONG LASTING FINISH

- Hot-dipped galvanized steel skin with a baked-on primer and top coat.

### DESIGN FLEXIBILITY

- Multiple steel texture embossments and panel designs.
- Multiple window options. Full-view section options in pre-painted Standard White or Chocolate available.
- Variety of color options.

### PEACE OF MIND

- Ten-year paint warranty.

\*Calculated door section R-value is in accordance with DASMA TDS-163.



2" ribbed steel doors are available with polystyrene insulation or non-insulated

### PANEL OPTIONS

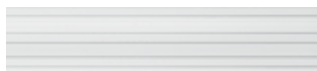

Deep Ribbed – Smooth Embossed  
(525, 524, 520)

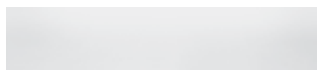

Flush – Smooth Embossed  
(522)



Classic Raised – Woodgrain Embossed  
(664, 664V)

### WINDOW OPTIONS



24" x 6"  
(520, 522, 524, 525)



24" x 12"  
(520, 522, 524, 525)



Aluminum Full-View  
(520, 522, 524, 525)



19-1/2" x 12"  
(664)

# COLOR OPTIONS – SECTIONAL DOORS



\*Additional charges apply.  
Due to the printing process, colors may vary.

AVAILABILITY		Standard White	Glacier White	Almond	Desert Tan	Sandtone	Commercial Tan	Bronze	Chocolate	Mocha Brown	Hunter Green	Gray	Charcoal	Black	Trinar® White	Trinar® Beige
ARCHITECTURAL SERIES	3158, 3159	■	■	■	■	■		■	■	■		■	■	■	■	
	3208, 3209	■							■			■		■	■	
	3708, 3709	■	■	■	■	■		■	■	■		■	■	■	■	
	3728, 3729	■	■	■	■	■		■	■	■		■	■	■	■	
ENERGY SERIES WITH INTELLOP®	3715	■	■			■			■	■		■	■			
	3717, 3718	■	■				■		■	■		■	■		■	■
	3720	■	■				■		■	■		■	■		■	■
	3722	■							■							
	3723, 3721	■		■	■	■			■			■	■			
	3724	■					■		■			■		■	■	
	3730	■					■		■			■		■	■	
ENERGY SERIES	3150	■	■				■		■	■		■	■			
	3200	■					■		■			■		■	■	
	3220	■							■							
	3154, 3155	■		■	■	■		■	■		■	■				
INDUSTRIAL SERIES	3211, 3213	■		■	■	■			■					■	■	■
	525, 525V, 525S	■							■							
	524, 524V, 524S	■					■		■			■			■	
	522, 522S	■							■							
	520, 520S	■							■							
	664, 664V	■		■	■	■			■							

For Model 902/903 color availability please refer to page 7.

## CUSTOM PAINT OPTION

Color Blast® finish offers more than 1,500 Sherwin-Williams® color options to complement your building's color scheme. The resilient, two-part polyurethane-based paint system is specially formulated for excellent adhesion and stability on steel, aluminum, vinyl and plastics. This provides a high-quality, durable and professional finish for your garage door.

- Available on most sectional steel, overlay and aluminum commercial door models. (Not available on flush models 522 and 522S, commercial pass doors and breakaway bottom sections.)
- Backed by a five-year warranty.
- Meets American Architectural Manufacturing Association 2604 standards.
- Solar reflective paint technology results in lower surface temperatures compared with standard paints and may be required on some products to allow darker colors to be used.
- Provide the Sherwin-Williams® 4-digit color code to get started with your match.

Some colors may not be available as an exact match. These include, but are not limited to, some bright colors such as reds, blues and greens required in solar reflective formulation, metallic colors or non-solid colors like woodgrains.

For more information visit: [www.clopaydoor.com/colorblast](http://www.clopaydoor.com/colorblast)



# FRAMING AND TRACK OPTIONS

## JAMB TYPES *(shown from above)*

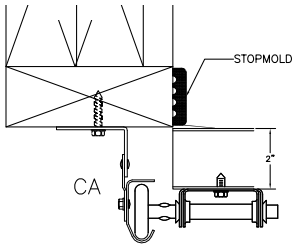

**2" WOOD JAMB**

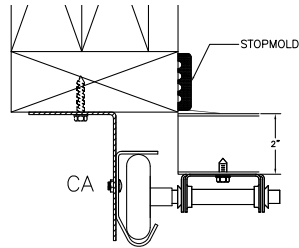

**3" WOOD JAMB**

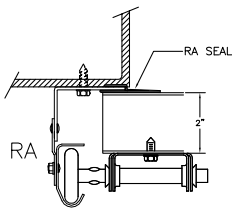

**2" STEEL JAMB**

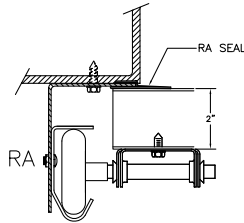

**3" STEEL JAMB**

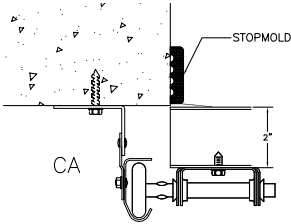

**2" MASONRY JAMB**

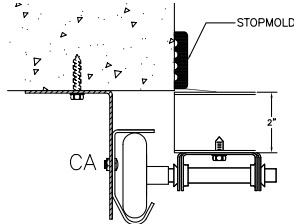

**3" MASONRY JAMB**

## VERTICAL TRACK MOUNTING OPTIONS

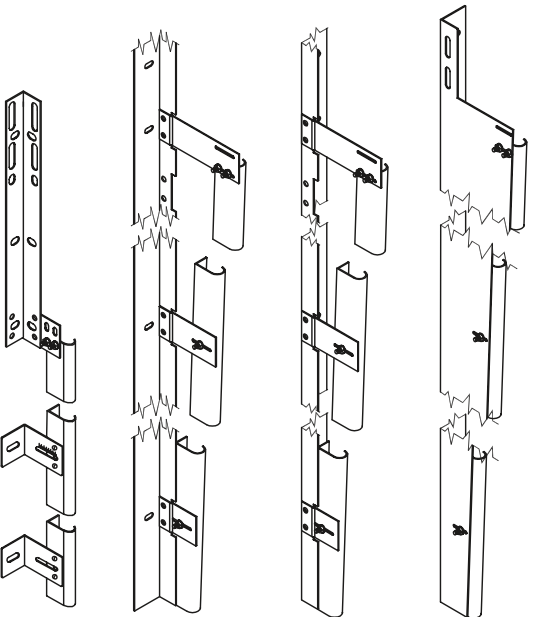

**2" BRACKET MOUNT**

**2" OR 3" CLIP MOUNT CONTINUOUS ANGLE**

**2" OR 3" CLIP MOUNT REVERSE ANGLE**

**3" FULL TAPERED REVERSE OR CONTINUOUS ANGLE**

## HIGH CYCLE SPRINGS



25,000, 50,000 or 100,000 cycle springs available.

## STANDARD RADIUS

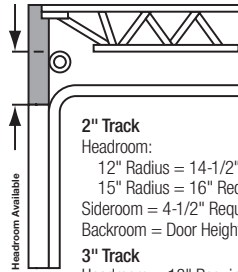

**2" Track**  
 Headroom:  
 12" Radius = 14-1/2" Required  
 15" Radius = 16" Required  
 Sideroom = 4-1/2" Required  
 Backroom = Door Height + 23" Required

**3" Track**  
 Headroom = 18" Required  
 Sideroom = 5-1/2" Required  
 Backroom = Door Height + 25" Required

## HIGH LIFT

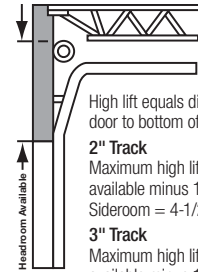

High lift equals distance from top of door to bottom of horizontal track.

**2" Track**  
 Maximum high lift equals headroom available minus 14"  
 Sideroom = 4-1/2" Required

**3" Track**  
 Maximum high lift equals headroom available minus 15"  
 Sideroom = 5-1/2" Required  
 (Minimum high lift = 12" Required)

## ROOF PITCH

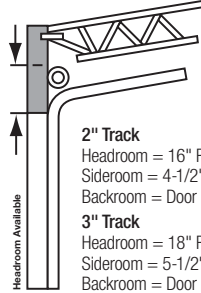

**2" Track**  
 Headroom = 16" Required  
 Sideroom = 4-1/2" Required  
 Backroom = Door Height + 23" Required

**3" Track**  
 Headroom = 18" Required  
 Sideroom = 5-1/2" Required  
 Backroom = Door Height + 25" Required

## VERTICAL LIFT

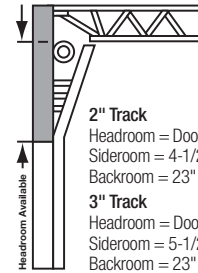

**2" Track**  
 Headroom = Door Height + 12" Required  
 Sideroom = 4-1/2" Required  
 Backroom = 23" Required

**3" Track**  
 Headroom = Door Height + 12" Required  
 Sideroom = 5-1/2" Required  
 Backroom = 23" Required

## LOW HEADROOM FRONT MOUNT

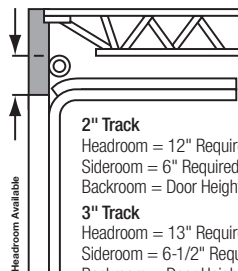

**2" Track**  
 Headroom = 12" Required  
 Sideroom = 6" Required  
 Backroom = Door Height + 23" Required

**3" Track**  
 Headroom = 13" Required  
 Sideroom = 6-1/2" Required  
 Backroom = Door Height + 25" Required  
 (1,200 lb. limit on door weight)

## LOW HEADROOM REAR MOUNT

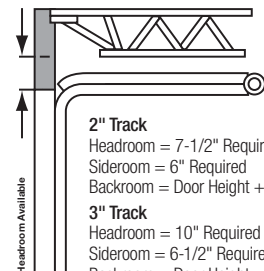

**2" Track**  
 Headroom = 7-1/2" Required  
 Sideroom = 6" Required  
 Backroom = Door Height + 30" Required

**3" Track**  
 Headroom = 10" Required  
 Sideroom = 6-1/2" Required  
 Backroom = Door Height + 32" Required  
 (800 lb. limit on door weight)

## HIGH LIFT WITH ROOF PITCH

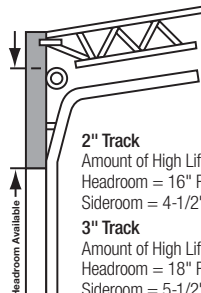

**2" Track**  
 Amount of High Lift + 16"  
 Headroom = 16" Required  
 Sideroom = 4-1/2" Required

**3" Track**  
 Amount of High Lift + 18"  
 Headroom = 18" Required  
 Sideroom = 5-1/2" Required

Headroom = Top of door to nearest obstruction (truss)

Up to 4" of additional headroom may be required for a trolley door opener.

**Note:** These are general headroom requirements. Additional headroom may be required depending on door type, door height, drums, spring type or other options selected.

# specialty sectional options



## REPLACEMENT SLAB SOLUTIONS

Replacement slabs feature 1-5/8" (41.3 mm) thick, CFC-free polyurethane insulation with a 14.86 R-value\*. A ribbed design and shi lap section joint make it a versatile replacement solution for many commercial service applications.

Sections are designed with a continuous steel reinforcement strip running along the top and bottom of the section, allowing them to be cut any length. The reinforcement strips can accommodate several hinge designs.

Replacement slab solutions are available in .015" (.38 mm) steel skin thickness with 21" (53.3 cm) and 24" (61 cm) section heights. Available only in Standard White.

\*Calculated door section R-value is in accordance with DASMA TDS-163.



# specialty sectional options

## ADDITIONAL SECTIONAL DOOR OPTIONS



### BREAK-AWAY BOTTOM SECTION

Break-away bottom sections are excellent in high-traffic dock areas where damage to the bottom sections of doors is a common occurrence.



### REMOVABLE CENTER MULLION

For openings that are wider than standard door width, consider using a carry-away, roll-away or swing-up mullion that enables two or more doors to close one opening.



### PASS DOOR

Pass doors are fitting for applications where space is too limited for the installation of a standard entry door. They conserve energy by allowing building access via a smaller opening versus the entire sectional door.



### SAFE-T-STOP™ CHAIN HOIST

Hand chain hoist with an integral braking system providing controlled descent for sectional doors.



### HIGH PERFORMANCE HARDWARE

High performance hardware features 10 gauge end hinges, heavy-duty top bracket and 3" (7.6 cm) sealed roller with 5/8" (15.9 mm) stem.



### EXTENDED 8-YEAR HARDWARE WARRANTY

Offers an 8-year limited warranty on all on-door hardware. Upgrades include 11 gauge hinges and 3" (76.2 mm) track.



### EXHAUST PORT

Can be cut into any type of sectional door. Available in 3" (7.6 cm) and 4" (10.2 cm) sizes.



### SPRING BUMPERS

Standard on high lift and vertical lift tracks, optional on standard radius and low headroom tracks.



### ADAPTER RAILS

Shiplap to tongue-and-groove. 16' (4.9 m) length prepainted Standard White.  
2" (50.8 mm) tongue-and-groove to tongue-and-groove. 16'2" (4.9 m) length prepainted Standard White or Chocolate.

# rolling steel series

## ROLLING SERVICE DOORS

- Constructed of a high percentage of recycled material and designed with ease of maintenance and longevity in mind, increasing the sustainability of most applications.
- Curtains are available in prefinished galvanized steel, stainless steel or anodized aluminum finishes. Guides, bottom bars and headplates are powder-coat finished for aesthetics and increased durability.
- Practical innovations enhanced by the aesthetic appeal ensure that a Clopay door adds value to any building exterior, combining maximum security with modest operating costs.
- Doors can be operated manually with standard chain hoist, or they can be motor operated. Optional manual crank operation is also available.

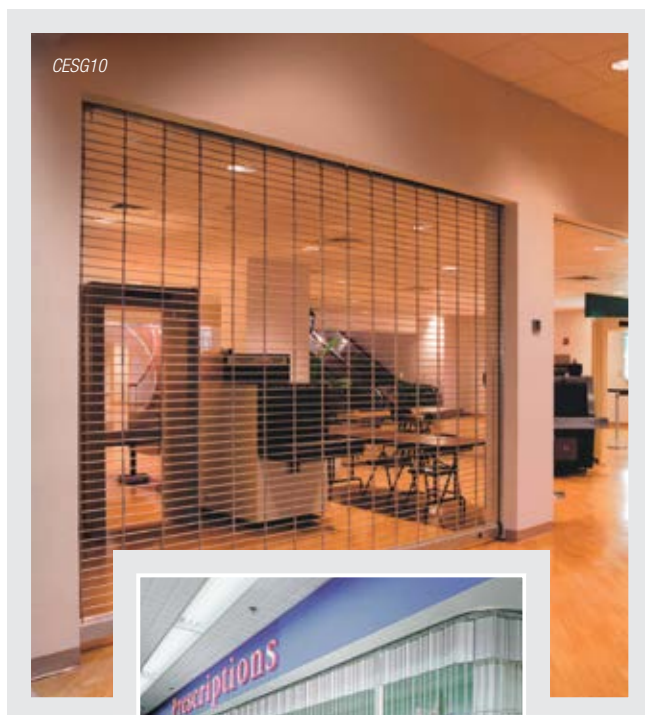

## SECURITY GRILLES

- After-hours security and space separation with visibility and air flow.
- Stainless steel, various anodized aluminum finishes and galvanized steel options.
- Standard pattern grille in 3" (7.6 cm), 6" (15.2 cm) or 9" (22.9 cm) vertical spacing. Popular brick pattern and glazed opening grilles.
- Structural self-supporting tubes available for installation of grille before storefronts or walls are installed.
- Provide security and access control in openings to 12' (3.7 m) high with low headroom conditions.
- Custom radii and angles offered.
- Offered in clear or color anodized finishes.
- Manufactured to the stringent qualities of the ISO 9001:2008 registered manufacturer.

## GRILLE PATTERNS



Standard Grille  
(2" x 3", 2" x 6", 2" x 9")



Brick Grille

# rolling steel series

## COUNTER SHUTTERS

- Manufactured to the stringent qualities of an ISO 9001:2008 registered manufacturer.
- Curtains are manufactured from 22 gauge stainless or galvanized steel, or 18 gauge aluminum.
- Operational choices include manual push-up, chain hoist, manual crank or electrical motor operation.
- The variety of installation options, product longevity and curtain options makes Clopay counter doors a great choice for informed design professionals.



## FIRE-RATED DOORS AND SHUTTERS

- Manufactured to the stringent qualities of full-duty service doors, yet easily meet the most current fire protection standards.
- Operational choices include fail-safe, motor-operated systems, hand crank (manual) and standard chain hoist operated systems.
- UL, FM and ULC labeled for fire protection up to four hours to meet today's fire protection demands.
- Clopay fire doors and shutters may be easily and repeatedly drop tested and reset from the floor with no tool or equipment requirements.
- The service durability, simplicity of ownership and proven fire protection with E-Z reset option [standard on doors larger than 9' x 9' (2.7 m x 2.7 m)] make Clopay fire doors a logical choice for informed design professionals.

## COLOR OPTIONS – ROLLING DOORS

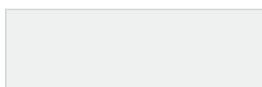

White



Tan



Gray



Brown

Custom powder coat  
RAL colors available.

*Due to the printing process, colors may vary.*

# rolling steel series

## ROLL-UP SHEET DOORS

Clopay roll-up sheet doors have a long lasting finish with excellent rust-resistance and are easy to install. These doors are ideal for mini-warehouse and storage facilities.

### LOW MAINTENANCE WITH LASTING FINISH

- 26 gauge (24 for W8 WindCode® rating) hot-dipped galvanized steel curtain with a baked-on silicone polyester finish inside.
- Hot-dipped galvanized steel, roll-formed guides (18 gauge 150C, 16 gauge 157C and 12 gauge 160C).
- Self-lubricating wear strips on curtain prevent metal-to-metal contact, providing quieter operation.
- Heavy-duty bottom bar withstands the external elements.
- Full bulb bottom weather-strip helps ensure proper fit along irregular floors.

### DESIGN OPTIONS

- Multiple color options.

### PEACE OF MIND

- Forty-year chalking warranty, twenty-five year anti-fade warranty.
- Three-year hardware warranty (150C), one-year hardware warranty (157C, 160C).



### CORRUGATED PANEL DESIGN

26 or 24 gauge steel, roll formed from ASTM A653 grade 80 full hard steel, interlocked and seamed together to make a continuous curtain for full height of door. *Model 157C shown.*



*Model 157C, Roll-Up Sheet Door*

## COLOR OPTIONS – ROLL-UP DOORS

			
Glossy White	White	Silhouette Gray	Light Stone
			
Desert Tan	Sandstone	Bronze	Continental Brown
			
Cedar Red	Valentine Red	Tangerine	Sunset Orange
			
Marine Green	Teal	Dark Teal	Fern Green
			
Evergreen	Forest Green	Royal Blue	Polar Blue

*Due to the printing process, colors may vary.*

*All colors are backed by a film integrity warranty for 40 years guaranteed to hold up against cracking, checking or peeling. In addition, these colors are guaranteed not to chalk or fade for 25 years.*

## COMMERCIAL OPERATORS

# LiftMaster®

GARAGE DOOR OPENERS



Clopay offers a full line of commercial openers designed to fit most applications.

- Jackshaft and trolley-driven openers to meet design and power requirements.
- Latest technology including MyQ® Technology to monitor or control the operator with Wi-Fi and smart phone capabilities.
- Available for single or three-phase power.
- Belt driven or gear driven to meet your specification requirements.
- Solenoid brakes are available on most models.
- Full line of safety equipment and accessories.

## ACCESSORIES



- Sensing edges.
- Red/green traffic lights.
- Loop detectors.
- Car wash/corrosion resistant modification.
- Many other modifications and accessories to meet your project requirements.

# WINDCODE®

Clopay has been at the forefront of code compliant sectional door products for decades. From research and development to design assistance, Clopay is your source for WINDCODE® products. Clopay offers a variety of wind-loaded products in many different sizes and pressure ratings. Our continued emphasis on this important issue puts Clopay ahead of the competition.



Some of the benefits Clopay offers include:

- Professional engineering staff.
- Design recommendations.
- In-house testing facilities.
- Third-party independent testing verifications.
- Construction industry approvals: South Florida, Standard Building Code Congress, Texas Department of Insurance, North Carolina Building Code Council.
- In-house research and development at Clopay Building Products Technical Center in Cincinnati, Ohio.
- Dedicated building code product manager on staff.

# own the opening

Clopay Corporation is a registered provider of continuing education through the American Institute of Architects. Our trained associates will provide AIA-approved training in the listed courses to you and your team through scheduled one-hour training programs. Reporting to AIA will be handled by Clopay.

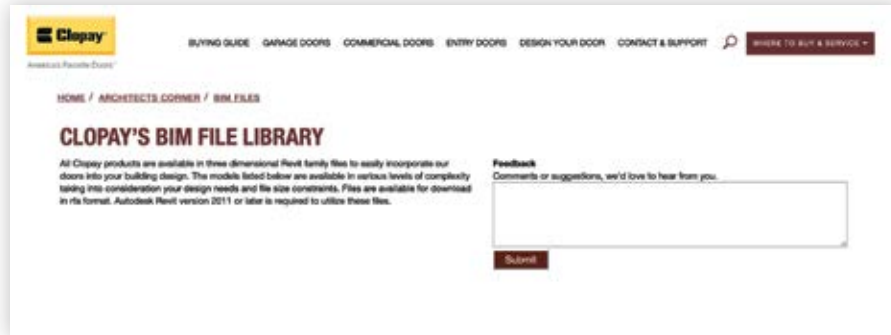

## BIM FILE LIBRARY

All Clopay products are available in three dimensional Revit family files to easily incorporate our doors into your building design. Files are available for download in rfa format. Autodesk Revit version 2011 or later is required to utilize these files.

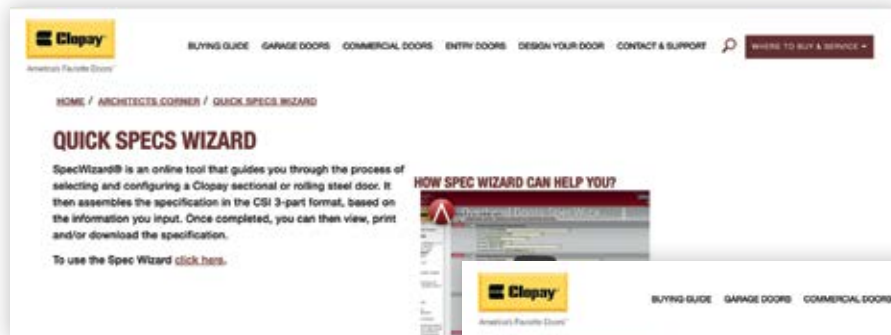

## QUICK SPECS WIZARD

SpecWizard® is an online tool that guides you through the process of selecting and configuring a Clopay sectional or rolling steel door.

## ARCHITECTS' CORNER

When you work with someone who thinks on your level, inspiration comes easy. You'll have the power to challenge conventions, push the limits and discover creative door solutions that complement your commercial building. With a responsive, experienced partner on your side and a wide selection of innovative products, success never looked so good.



# upgrading expectations

## Spokane International Airport Snow Removal Equipment Building

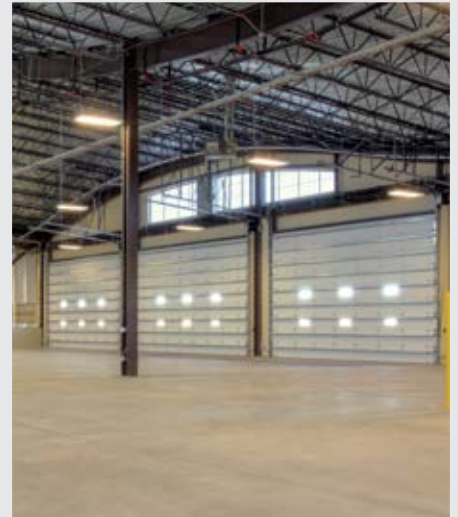

### COLLABORATIVE DESIGN

Clopay partnered with a Master Authorized Dealer®, Continental Door Company, to design and install 28 commercial doors on Spokane International Airport's (SIA) new \$7.5 million snow removal building. The combination of Model 3722 overhead sectional steel doors and Model 903 full-view aluminum doors contributed to the building's LEED Gold certification and striking appearance.

### ENGINEERED SOLUTION

Clopay engineers and the Continental Door team collaborated on designing doors to fit the installation challenges of the uniquely shaped building while delivering a solution that is extremely reliable, safe and efficient. The result is a visually stunning installation that features door hardware on a straight incline in lieu of a breakaway track, a custom staggered hinge scheme and 4' and 6' struts to meet demanding wind load requirements. The ruggedness of the 2" thick premium Model 3722, 20 gauge steel doors ensures low maintenance in an environment that is subjected to high traffic and harsh winter conditions.

---

### CASE STUDY OVERVIEW:

- Location: Spokane, Washington
- Project Size: 46,400 square feet
- Facility Cost: \$7.5 million, LEED Gold certification
- Completion: June 2013
- Architect: Cortner Architectural
- General Contractor: Lydig Construction Inc., of Spokane
- Clopay Garage Door Installer: Continental Door Company

# PRODUCT SELECTION CHART

ARCHITECTURAL SERIES (ALUMINUM FULL-VIEW DOORS)								
Model	Steel Emboss	Exterior Skin Pattern	Gauge	Section Thickness	Insulation	Max. Width*	Max. Height*	R-value
902	–	Aluminum/Glass	–	2-1/8"	–	24'2"	18'0"	–
903	–	Aluminum/Glass	–	2-1/8"	–	24'2"	18'0"	–
904	–	Aluminum/Glass	–	2-1/8"	–	24'2"	20'0"	–

ARCHITECTURAL SERIES (STEEL FULL-VIEW DOORS)								
Model	Steel Emboss	Exterior Skin Pattern	Gauge	Section Thickness	Insulation	Max. Width*	Max. Height*	R-value
3158 <sup>†</sup>	Stucco	Flush	27	1-3/8"	Bonded Polystyrene	18'2"	16'0"	6.5 <sup>‡</sup>
3159 <sup>†</sup>	Stucco	Minor Ribbed	27	1-3/8"	Bonded Polystyrene	18'2"	16'0"	6.5 <sup>‡</sup>
3208 <sup>†</sup>	Stucco	Flush	24	2"	Bonded Polystyrene	20'2"	18'0"	9.1 <sup>‡</sup>
3209 <sup>†</sup>	Stucco	Minor Ribbed	24	2"	Bonded Polystyrene	20'2"	18'0"	9.1 <sup>‡</sup>
3708 <sup>†</sup>	Stucco	Flush	27	1-3/8"	Intellicore <sup>®</sup> Polyurethane	18'2"	16'0"	12.9 <sup>‡</sup>
3709 <sup>†</sup>	Stucco	Minor Ribbed	27	1-3/8"	Intellicore <sup>®</sup> Polyurethane	18'2"	16'0"	12.9 <sup>‡</sup>
3728 <sup>†</sup>	Stucco	Flush	27	2"	Intellicore <sup>®</sup> Polyurethane	20'2"	18'0"	18.4 <sup>‡</sup>
3729 <sup>†</sup>	Stucco	Minor Ribbed	27	2"	Intellicore <sup>®</sup> Polyurethane	20'2"	18'0"	18.4 <sup>‡</sup>

ENERGY SERIES WITH INTELLICORE								
Model	Steel Emboss	Exterior Skin Pattern	Gauge	Section Thickness	Insulation	Max. Width*	Max. Height*	R-value
3715 <sup>†</sup>	Stucco	Minor Ribbed	27	1-3/8"	Intellicore <sup>®</sup> Polyurethane	18'2"	16'0"	12.9
3717 <sup>†</sup>	Stucco	Minor Ribbed	27	1-3/4"	Intellicore <sup>®</sup> Polyurethane	32'2"	26'0"	16.2
3718 <sup>†</sup>	Stucco	Flush	27	1-3/4"	Intellicore <sup>®</sup> Polyurethane	32'2"	26'0"	16.2
3720 <sup>†</sup>	Stucco	Minor Ribbed	27	2"	Intellicore <sup>®</sup> Polyurethane	40'2"	26'0"	18.4
3721 <sup>†</sup>	Woodgrain	Flush	27	2"	Intellicore <sup>®</sup> Polyurethane	24'2"	18'0"	18.4
3722 <sup>†</sup>	Stucco	Flush	20	2"	Intellicore <sup>®</sup> Polyurethane	40'2"	26'0"	18.4
3723 <sup>†</sup>	Woodgrain	Raised Panel	27	2"	Intellicore <sup>®</sup> Polyurethane	24'2"	18'0"	18.4
3724 <sup>†</sup>	Stucco	Minor Ribbed	24	2"	Intellicore <sup>®</sup> Polyurethane	40'2"	26'0"	18.4
3730 <sup>†</sup>	Stucco	Minor Ribbed	27	3"	Intellicore <sup>®</sup> Polyurethane	30'2"	18'0"	27.2

ENERGY SERIES								
Model	Steel Emboss	Exterior Skin Pattern	Gauge	Section Thickness	Insulation	Max. Width*	Max. Height*	R-value
3150 <sup>†</sup>	Stucco	Minor Ribbed	27	1-3/8"	Bonded Polystyrene	18'2"	16'0"	6.5
3154 <sup>†</sup>	Woodgrain	Raised Panel	27	1-3/8"	Bonded Polystyrene	18'2"	16'0"	6.5
3155 <sup>†</sup>	Woodgrain	Flush	27	1-3/8"	Bonded Polystyrene	18'2"	16'0"	6.5
3200 <sup>†</sup>	Stucco	Minor Ribbed	24	2"	Bonded Polystyrene	26'2"	24'0"	9.1
3211 <sup>†</sup>	Woodgrain	Flush	24	2"	Bonded Polystyrene	24'2"	18'0"	9.1
3213 <sup>†</sup>	Woodgrain	Raised Panel	24	2"	Bonded Polystyrene	24'2"	18'0"	9.1
3220 <sup>†</sup>	Stucco	Flush	20	2"	Bonded Polystyrene	28'2"	26'0"	9.1

INDUSTRIAL SERIES								
Model	Steel Emboss	Exterior Skin Pattern	Gauge	Section Thickness	Insulation	Max. Width*	Max. Height*	R-value
520 (S)	Smooth	Minor+Deep Ribs	20	2"	Polystyrene or Non-insulated	32'2"	26'0"	6.6**
522 (S)	Smooth	Flush	20	2"	Polystyrene or Non-insulated	24'2"	24'0"	6.6**
524 (S,V)	Smooth	Minor+Deep Ribs	24	2"	Polystyrene or Non-insulated	26'2"	24'0"	6.6**
525 (S,V)	Smooth	Minor+Deep Ribs	25	2"	Polystyrene or Non-insulated	20'2"	18'0"	6.6**
664 (V)	Woodgrain	Raised Panel	24	2"	Polystyrene or Non-insulated	20'0"	18'0"	6.3**

ROLLING STEEL DOORS								
Service Doors								
Model	Description	Insulation	Gauge	R-value	Slat Material			
CESD10	Heavy Duty Service Door	Non-insulated	18 to 24	–	Aluminum, Galvanized or Stainless Steel			
CESD20	Heavy Duty Service Door	Insulated	18 to 24	8.1	Aluminum, Galvanized or Stainless Steel			
CERD10	Heavy Duty Fire Rated Service Door	Non-insulated	18 to 22	–	Galvanized Steel or Stainless Steel			
CERD11	Heavy Duty Fire & Smoke Rated Service Door	Non-insulated	18 to 22	–	Galvanized Steel or Stainless Steel			
CERD20	Heavy Duty Fire Rated Service Door	Insulated	18 to 22	8.1	Galvanized Steel or Stainless Steel			
CERD21	Heavy Duty Fire & Smoke Rated Service Door	Insulated	18 to 22	8.1	–			

Security Grilles								
Model	Description	Pattern				Material		
CESG10	Rolling Grille	Standard				Stainless Steel or Galvanized Steel		
CESG11	Lexan™ Glazed Rolling Grille	Lexan™				Stainless Steel or Galvanized Steel		
CESG12	Rolling Grille	Brick				Stainless Steel or Galvanized Steel		
CESG30	Side Folding (accordion) Grille	Standard (9", 6" or 3" wide by 2" high)			Aluminum			
CESG31	Side Folding Lexan™ or Solid Grille	Solid or Lexan™			Aluminum			

Counter Doors								
Model	Description	Insulation	Gauge	R-value	Slat Material			
CESC10	Standard Counter Door	–	18 or 22	–	Aluminum, Galvanized or Stainless Steel			
CESC20	Standard Counter Door with Integral Frame	–	18 or 22	–	Aluminum, Galvanized or Stainless Steel			
CERC10	Standard Fire Rated Counter Door	–	22	–	Galvanized or Stainless Steel			
CERC20	Standard Fire Rated Counter Door with Integral Frame	–	22	–	Galvanized or Stainless Steel			

Rolling Sheet Doors								
Model	Description	Insulation	Curtain Gauge	Coil	Material			
150C	Light Duty	Available	26	9"	Galvanized Steel			
157C	Medium Duty	Available	26	12"	Galvanized Steel			
160C	Heavy Duty	Available	26	12"	Galvanized Steel			

\*Consult CIA for large sizes. All widths may not be available in all heights. \*\*For insulated models (S, V) only.

<sup>†</sup>Cloday complies with the 2015 IECC (International Energy Conservation Code) with an air infiltration rating of .40 cfm/ft<sup>2</sup> or less (IECC, Section 402.5.2), and also meets the U-factor requirement of .37 or less (IECC, Section C402.4, for Climate Zones 1 through 8).

<sup>‡</sup>R-value is impacted by the number of windows and window type per section.

Calculated R-values for doors featuring a full row of 3/4" (19.1 mm) insulated windows is available on our website.

## Find Your Solution With Cloday



Our team of Cloday commercial door experts is always ready to assist. To find the Cloday commercial door that's right for your application, call **1-800-526-4301**, visit [clodaycommercial.com](http://clodaycommercial.com) or email [CIA@cloday.com](mailto:CIA@cloday.com). To locate a dealer go to [clodaydoor.com/where-to-buy/commercial](http://clodaydoor.com/where-to-buy/commercial) or call **1-800-2CLOPAY (225-6729)**.



©2021 Cloday Corporation. All rights reserved.

CMDC-IDEA-15\_REV0221